

Data Sheet



Article number: 3901044010100

Description: Worm gear with solid input shaft
VF 44N-10-HS

Measures

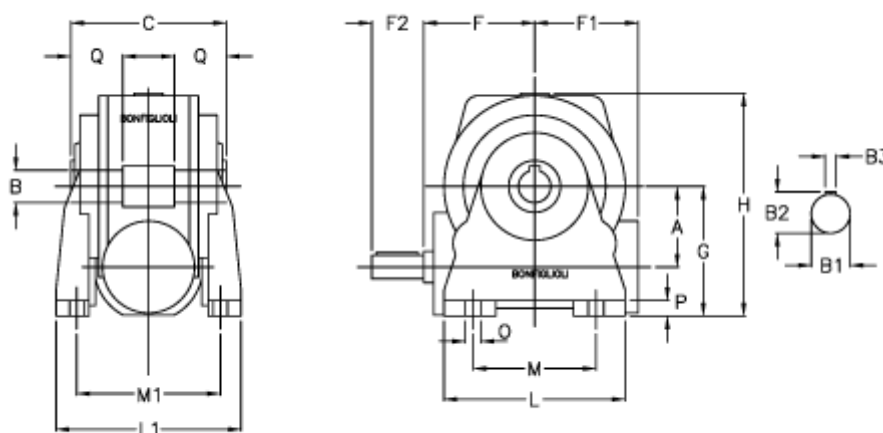

a	= 44.6	F1 = 54	O = 8.5
B	= 18	F2 = 30	P = 10
B1	= 11	g = 72	Q = 24.5
B2	= 12.5	H = 124.5	
B3	= 4	L = 90	
C	= 64	L1 = 98	
Description = VF 44N-xx-HS		m = 52	
F	= 54.0	M1 = 81.0	